

**JUMO GmbH & Co. KG**

Delivery address: Mackenrodtstraße 14,  
36039 Fulda, Germany  
Postal address: 36035 Fulda, Germany  
Phone: +49 661 6003-0  
Fax: +49 661 6003-607  
E-mail: mail@jumo.net  
Internet: www.jumo.net

**JUMO Instrument Co. Ltd.**

JUMO House  
Temple Bank, Riverway  
Harlow - Essex CM20 2DY, UK  
Phone: +44 1279 63 55 33  
Fax: +44 1279 63 52 62  
E-mail: sales@jumo.co.uk  
Internet: www.jumo.co.uk

**JUMO Process Control, Inc.**

8 Technology Boulevard  
Canastota, NY 13032, USA  
Phone: 315-697-JUMO  
1-800-554-JUMO  
Fax: 315-697-5867  
E-mail: info@jumo.us  
Internet: www.jumo.us



# Pneumatic Retractable Assembly

Type 202823

## Brief description

Pneumatic retractable assemblies are used wherever sensors are exposed to exceptional loadings. These can be applications with heavy contamination or precipitation, as well as special process conditions (such as sterilizability, hygienic applications, etc.). The regular, automated cleaning of the sensor can significantly increase its service life in problematic medium conditions. The type 202823 pneumatic retractable assembly can hold all standard commercial sensors that are 12 mm in diameter and 225 mm long. In order to cope with the diverse process properties, the process fitting is supplied in stainless steel (1.4404 / 316L). Different seal materials are also available.

The fitting can be adapted to containers or pipelines by a flange or relevant flow-through vessel. A version with (EHEDG/3A) certified process connections is available for use in pharmaceutical applications.

The JUMO 202823 pneumatic retractable assembly can be operated in any position. But to obtain reliable measurements, the properties of the sensor being used must be considered.

## Advantages

- Suitable for all standard commercial sensors that are 225 mm long, 12 mm in diameter and with a Pg 13.5 thread
- Sturdy design
- Increases sensor service life
- Reduces maintenance expenditure
- Safety lock for when sensor is removed
- Integrated positional feedback
- Simple installation and sensor mounting
- Can be used up to 10 bar and +140 °C (version-dependent)
- Wide choice of process connections and seal materials
- Maintenance-free drive unit
- EHEDG and 3A certified version available

## Areas of application

- Harsh process conditions (precipitation, heavy contamination)
- Water and wastewater engineering
- Pharmaceutical industry
- Chemical industry
- Food technology



Type 202823...

**JUMO GmbH & Co. KG**  
 Delivery address: Mackenrodtstraße 14,  
 36039 Fulda, Germany  
 Postal address: 36035 Fulda, Germany  
 Phone: +49 661 6003-0  
 Fax: +49 661 6003-607  
 E-mail: mail@jumo.net  
 Internet: www.jumo.net

**JUMO Instrument Co. Ltd.**  
 JUMO House  
 Temple Bank, Riverway  
 Harlow - Essex CM20 2DY, UK  
 Phone: +44 1279 63 55 33  
 Fax: +44 1279 63 52 62  
 E-mail: sales@jumo.co.uk  
 Internet: www.jumo.co.uk

**JUMO Process Control, Inc.**  
 8 Technology Boulevard  
 Canastota, NY 13032, USA  
 Phone: 315-697-JUMO  
 1-800-554-JUMO  
 Fax: 315-697-5867  
 E-mail: info@jumo.us  
 Internet: www.jumo.us



## Functional description of the fitting

The fitting can either be operated by an external (PLC) controller, or by the control unit that is available as an option. To start measurement, compressed air is supplied to the fitting via the pneumatic connections of the drive unit (1). The pneumatic drive unit inserts the immersion tube (3) into the process medium to the maximum immersion depth. A safety device prevents the immersion tube being inserted when there is no sensor installed. When the "Measure" end position is reached, the controller receives pneumatic positional feedback. In this position, the terminal head of the sensor is concealed in the drive unit, making it impossible to remove the sensor. Now the process liquid measurements are taken. If it is necessary to clean the sensor, the sensor can be withdrawn from the medium without interrupting the process. To do this, move the fitting to the "Service" position. Positional feedback from the controller also indicates when this position is reached. The rinsing chamber is protected by seals in the "Service" position, so that no process liquid can escape.

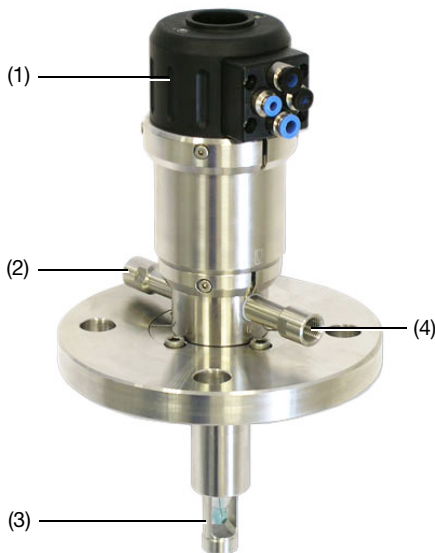

- (1) Drive unit with connections
- (2) "IN" rinsing connection
- (3) Immersion tube (in "Measure" position)
- (4) "OUT" rinsing connection

The complete cleaning sequence comprises the following components:

- EXmatic 460 control unit or PLC (provided by customer)
- 20.2823 pneumatic retractable assembly
- Flow-through vessel (T-piece)
- pH combination electrode
- Electrode cable
- pH transmitter with washing contact
- Valves

The following components must be provided and made available by the customer:

- Power supply
- Cleaning solutions / chemicals
- Rinsing liquid (water, or similar)
- Compressed air

The process fitting is connected to the control unit by color-coded connecting cables. This prevents the cables getting mixed up.

## Functional description of the EXmatic 460

The EXmatic 460 fitting controller can control and monitor the measuring and cleaning cycles of the pneumatic retractable assembly totally automatically. Cleaning cycles, measuring intervals and start times can be parameterized and adapted to a particular requirement. The controller monitors all the positional feedback from the retractable assembly via the integrated inputs. Automatic cleaning can be started via an additional input. The respective states of the retractable assembly and the controller can be forwarded to a higher-level process control system. The retractable assembly and cleaning valves to control the cleaning solutions are connected to the fitting controller by means of pneumatic hoses. The automatic cleaning cycle can basically be started using 3 different programs.

It is also possible to combine the cycles.

- **Loop**  
Recurring cycle
- **Real-Time Event**  
At certain times, e.g. every day
- **External Trigger**  
Start via external contact
- **Loop + Trigger**  
When system is at a standstill, for example, to avoid dry periods
- **Event + Trigger**  
For wetting when sensor is at a standstill, for example

When the retractable assembly is moved to the "Cleaning" position, or back to the "Measure" position, there is a connection between the product and the rinsing chamber for a brief moment, when the measuring window passes the sealing element. A seal water function can be activated so that as little product as possible gets into the rinsing chamber, and so that the sealing element is

also rinsed at the same time.

When the cleaning program is started, the following program steps are run (depending on the setting):

- **Cleaning I/1**  
Pre-cleaning, e.g. with water
- **Cleaning II**  
Cleaning with second solution, e.g. acid
- **Cleaning II RT**  
Reaction time for second solution; skipped when value "0"
- **Cleaning I/2**  
Cleaning with first solution, e.g. water
- **Pause**  
Sensor stays in rinsing chamber, cleaning solution not blown out; skipped when value "0"
- **Measure**  
Sensor back to measuring position

## Cleaning sequence via pH transmitter with washing contact

The cleaning process is started by the pH transmitter using the washing contact. The external EXmatic 460 must be programmed to the "External Trigger" function.

Compressed air is supplied to the fitting via the pneumatic connections of the drive unit (1). The pneumatic drive unit withdraws the immersion tube (3) from the medium. When the "Service" position is reached, positional feedback is given to the controller. The rinsing chamber is protected by seals in this position, so that no process liquid can escape. Now the actual cleaning process can be run in accordance with the selected program. When the relevant valves are activated, fresh rinsing liquid is carried to the sensor through the "IN" rinsing input (2). The polluted rinsing liquid is removed via the "OUT" rinsing connection (4). Once all the cleaning steps have been executed, and subject to the program selected, the rinsing chamber is rinsed and the sensor is moved back to the "Measure" position by the drive unit.

## Periodic measuring mode

With highly aggressive media, or media that is susceptible to precipitation, and which could therefore impair the functionality of the sensor, the controller can be programmed so that the sensor is only immersed in the process in time-limited phases. In this case, the liquid (cleaning solution 1) is left in the rinsing chamber. The remaining liquid is used to keep the sensor moist and to stop it drying out.

**JUMO GmbH & Co. KG**  
 Delivery address: Mackenrodtstraße 14,  
 36039 Fulda, Germany  
 Postal address: 36035 Fulda, Germany  
 Phone: +49 661 6003-0  
 Fax: +49 661 6003-607  
 E-mail: mail@jumo.net  
 Internet: www.jumo.net

**JUMO Instrument Co. Ltd.**  
 JUMO House  
 Temple Bank, Riverway  
 Harlow - Essex CM20 2DY, UK  
 Phone: +44 1279 63 55 33  
 Fax: +44 1279 63 52 62  
 E-mail: sales@jumo.co.uk  
 Internet: www.jumo.co.uk

**JUMO Process Control, Inc.**  
 8 Technology Boulevard  
 Canastota, NY 13032, USA  
 Phone: 315-697-JUMO  
 Fax: 1-800-554-JUMO  
 Fax: 315-697-5867  
 E-mail: info@jumo.us  
 Internet: www.jumo.us



## Technical data

### 202823 pneumatic retractable assembly

<b>Materials</b>	
- Parts in contact with the medium for material 24 (stainless steel)	1.4404 / 316L stainless steel
- Drive unit	1.4404 / 316L stainless steel, PA66 GF30
- Seals	EPDM (standard)
<b>Operating temperature<sup>1</sup></b>	
- Max. permissible temperature	+140 °C
<b>Pressure resistance<sup>1</sup></b>	
- Max. permissible pressure	16 bar
<b>Rinsing pressure<sup>1</sup></b>	1 to 4 bar
<b>Suitable for 1 sensor</b>	225 mm long, 12 mm in diameter and with a Pg 13.5 thread
<b>Process connection</b>	DN50 flange; Other versions on request
<b>Rinsing connection</b>	G 1/8" or G 1/4" (internal)
<b>Pneumatic connection</b>	
- Control air	Compressed air hoses
- Positional feedback	external ø 6 mm, internal 4 mm external ø 4 mm, internal 2 mm

<sup>1</sup> Comply with the maximum permissible sensor temperature and pressure!

### Permissible pressure and temperature

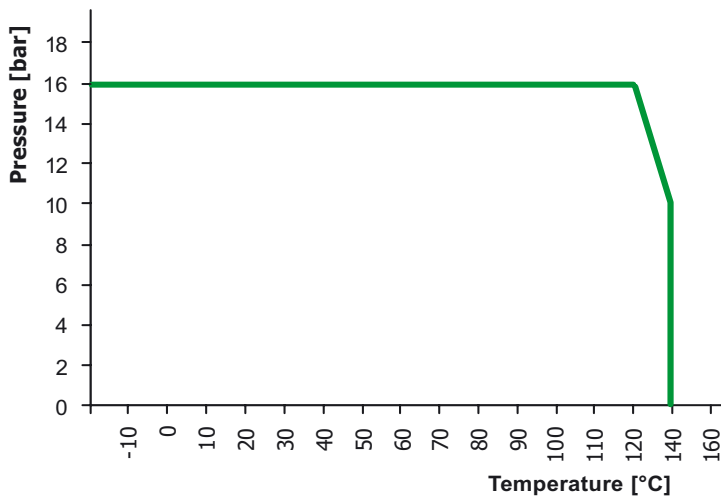

**JUMO GmbH & Co. KG**  
 Delivery address: Mackenrodtstraße 14,  
 36039 Fulda, Germany  
 Postal address: 36035 Fulda, Germany  
 Phone: +49 661 6003-0  
 Fax: +49 661 6003-607  
 E-mail: mail@jumo.net  
 Internet: www.jumo.net

**JUMO Instrument Co. Ltd.**  
 JUMO House  
 Temple Bank, Riverway  
 Harlow - Essex CM20 2DY, UK  
 Phone: +44 1279 63 55 33  
 Fax: +44 1279 63 52 62  
 E-mail: sales@jumo.co.uk  
 Internet: www.jumo.co.uk

**JUMO Process Control, Inc.**  
 8 Technology Boulevard  
 Canastota, NY 13032, USA  
 Phone: 315-697-JUMO  
 1-800-554-JUMO  
 Fax: 315-697-5867  
 E-mail: info@jumo.us  
 Internet: www.jumo.us



## Technical data

### EXmatic 460 controller for the pneumatic retractable assembly

<b>Material</b> Housing Control unit	GFRP or stainless steel (option) GFRP, PMMA
<b>Enclosure protection</b> to EN 60529 Housing Control unit	IP54 IP54
<b>Dimensions</b>	300 mm x 400 mm x 200 mm for both versions
<b>Ambient conditions</b> Ambient temperature Transport and storage temperature Relative humidity	0 to +55 °C -10 to +60 °C 10 to 95 %, non-condensing
<b>Electrical ratings</b> Power supply Power consumption Power draw Input external contact pneumatic valve control Output external contact cleaning pump I cleaning pump II status contact alarm contact	24 V DC ≤ 0.65 A ≤ 30 VA  24 V DC internal power supply for floating contact 24 V DC, ≤ 80 mA  24 V DC, ≤ 80 mA 24 V DC, ≤ 80 mA 24 V DC, ≤ 80 mA 24 V DC, ≤ 100 mA 24 V DC, ≤ 100 mA
<b>EMC</b> Interference emission Interference immunity	Radio-interference-suppressed to 61000-6-4 Noise-immune to EN 61000-6-2
<b>Pneumatics</b> (compressed air) Connection for control air external diameter internal diameter Connection for positional feedback external diameter internal diameter Pressure Quality Consumption	Compressed air hose ø 6 mm ø 4 mm Compressed air hose ø 4 mm ø 2 mm 4 to 6 bar Filtered ≤ 40 µm; water and oil free No continuous air consumption

**JUMO GmbH & Co. KG**  
 Delivery address: Mackenrodtstraße 14,  
 36039 Fulda, Germany  
 Postal address: 36035 Fulda, Germany  
 Phone: +49 661 6003-0  
 Fax: +49 661 6003-607  
 E-mail: mail@jumo.net  
 Internet: www.jumo.net

**JUMO Instrument Co. Ltd.**  
 JUMO House  
 Temple Bank, Riverway  
 Harlow - Essex CM20 2DY, UK  
 Phone: +44 1279 63 55 33  
 Fax: +44 1279 63 52 62  
 E-mail: sales@jumo.co.uk  
 Internet: www.jumo.co.uk

**JUMO Process Control, Inc.**  
 8 Technology Boulevard  
 Canastota, NY 13032, USA  
 Phone: 315-697-JUMO  
 1-800-554-JUMO  
 Fax: 315-697-5867  
 E-mail: info@jumo.us  
 Internet: www.jumo.us



## Dimensions

### Pneumatic retractable assembly

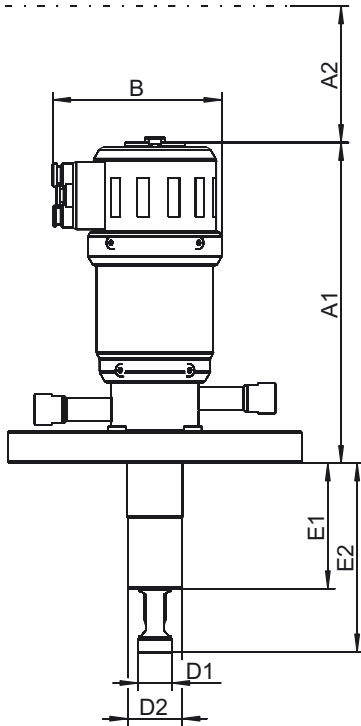

Dimension	Process connection 733
A1	180 mm
A2	350 mm
B	95 mm
D1	19 mm
D2	31 mm
E1	71 mm
E2	107 mm

### Flow-through vessel (T-piece) Sales No.: 20/00542773

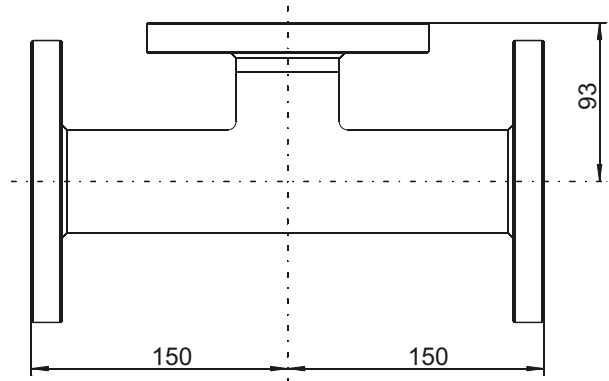

### EXmatic 460 controller

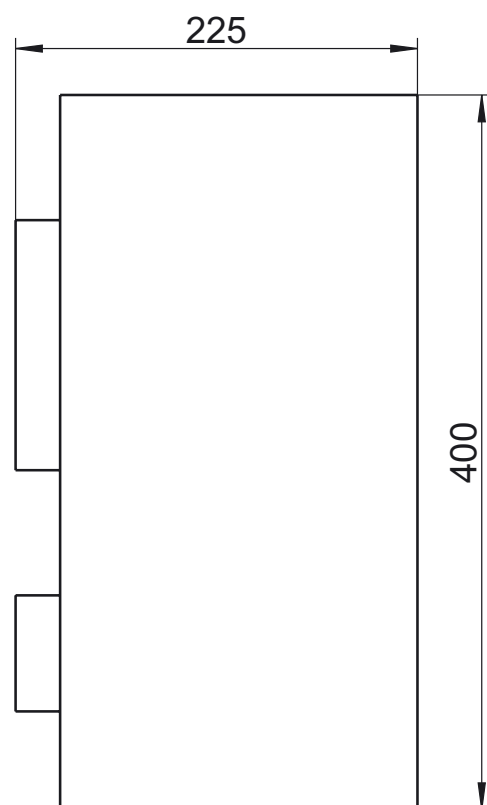
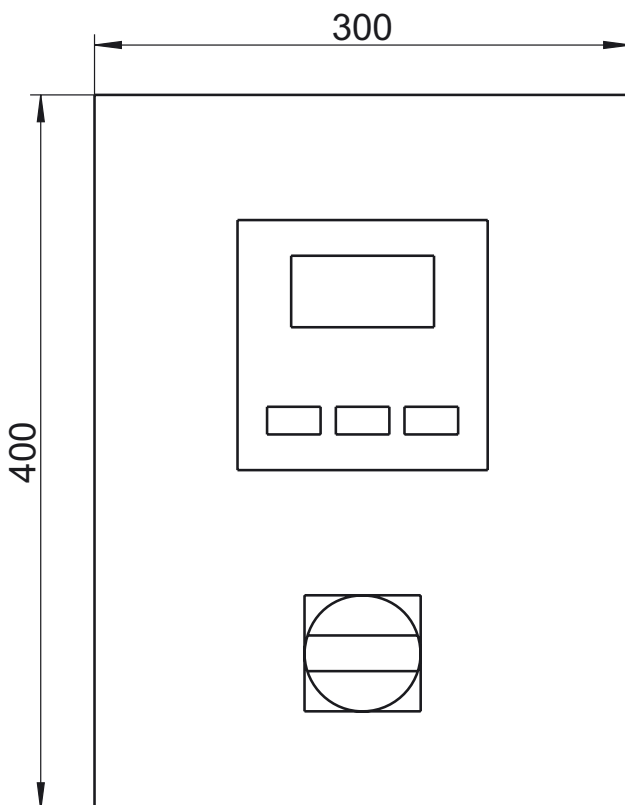

**JUMO GmbH & Co. KG**  
 Delivery address: Mackenrodtstraße 14,  
 36039 Fulda, Germany  
 Postal address: 36035 Fulda, Germany  
 Phone: +49 661 6003-0  
 Fax: +49 661 6003-607  
 E-mail: mail@jumo.net  
 Internet: www.jumo.net

**JUMO Instrument Co. Ltd.**  
 JUMO House  
 Temple Bank, Riverway  
 Harlow - Essex CM20 2DY, UK  
 Phone: +44 1279 63 55 33  
 Fax: +44 1279 63 52 62  
 E-mail: sales@jumo.co.uk  
 Internet: www.jumo.co.uk

**JUMO Process Control, Inc.**  
 8 Technology Boulevard  
 Canastota, NY 13032, USA  
 Phone: 315-697-JUMO  
 1-800-554-JUMO  
 Fax: 315-697-5867  
 E-mail: info@jumo.us  
 Internet: www.jumo.us



Complete measurement section

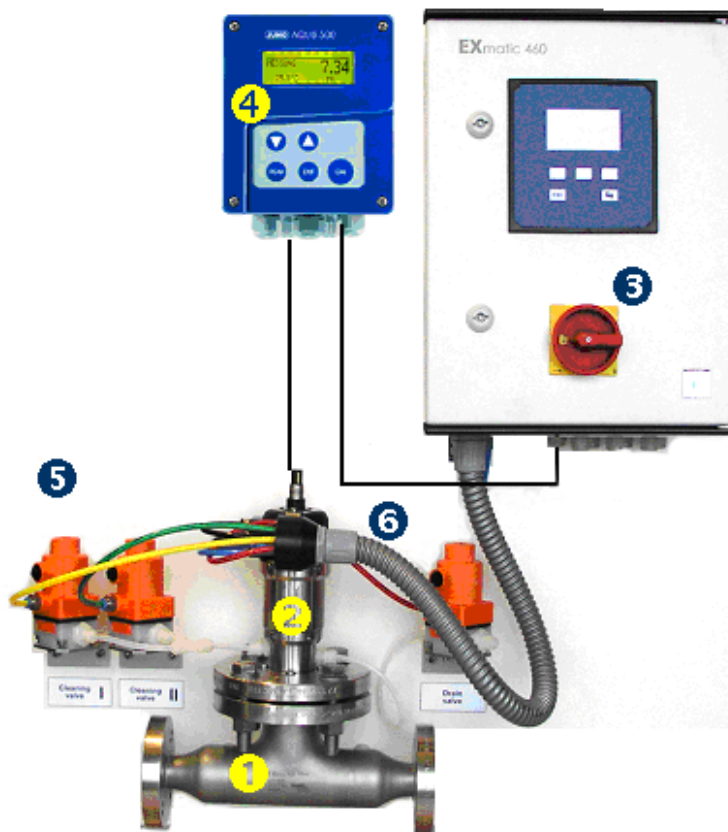

(1)	T-piece mounting (20/00542773)
(2)	Type 202823 pneumatic retractable assembly
(3)	Type EXmatic 460 controller for the pneumatic retractable assembly
(4)	Transmitter/controller for pH value, e. g. JUMO AQUIS 500 pH type
(5)	Pneumatic valves for cleaning
(6)	Pneumatic valves for draining



# Connection diagram

EXmatic460

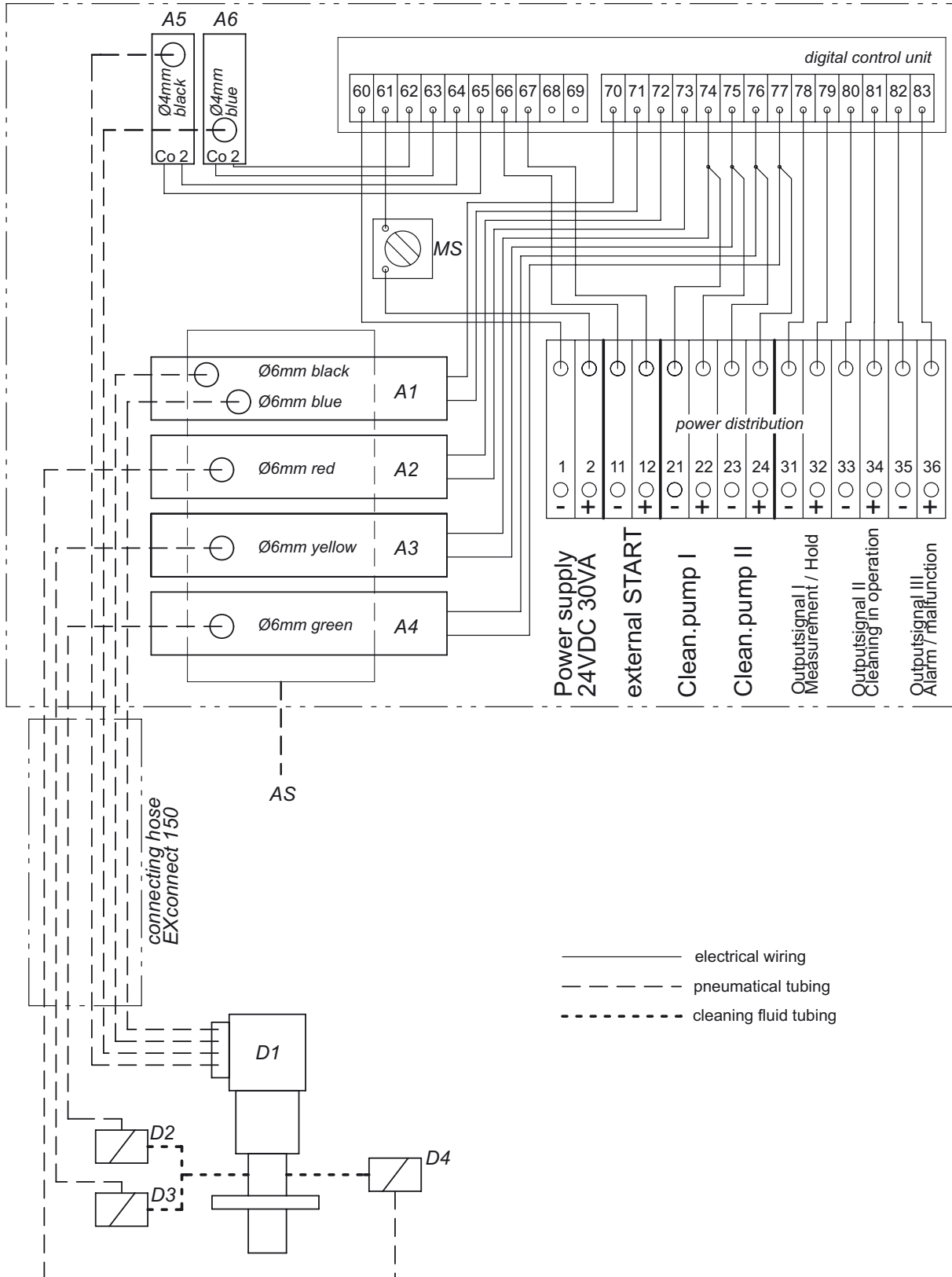

**JUMO GmbH & Co. KG**  
 Delivery address: Mackenrodtstraße 14,  
 36039 Fulda, Germany  
 Postal address: 36035 Fulda, Germany  
 Phone: +49 661 6003-0  
 Fax: +49 661 6003-607  
 E-mail: mail@jumo.net  
 Internet: www.jumo.net

**JUMO Instrument Co. Ltd.**  
 JUMO House  
 Temple Bank, Riverway  
 Harlow - Essex CM20 2DY, UK  
 Phone: +44 1279 63 55 33  
 Fax: +44 1279 63 52 62  
 E-mail: sales@jumo.co.uk  
 Internet: www.jumo.co.uk

**JUMO Process Control, Inc.**  
 8 Technology Boulevard  
 Canastota, NY 13032, USA  
 Phone: 315-697-JUMO  
 Fax: 1-800-554-JUMO  
 Fax: 315-697-5867  
 E-mail: info@jumo.us  
 Internet: www.jumo.us



**Order details:**      **Process immersion fitting**

**(1) Basic type**

	202823	Pneumatic retractable assembly
	<b>(2) Material</b>	
x	24	1.4404 / 316L stainless steel
	<b>(3) Process connection<sup>1</sup></b>	
x	733	DN50 flange, EN 1092/1 Form A
	<b>(4) Cleaning connection</b>	
x	101	internal G 1/8"
o	102	internal G 1/4"
	<b>(5) Seal</b>	
x	600	EPDM seal
o	601	FPM seal
	<b>(6) Extra codes</b>	
o	000	none
x	920	Pneumatic positional feedback

x = standard  
 o = option  
 - = not available

<b>Order code</b>	(1)	-	(2)	-	(3)	-	(4)	-	(5)	/	(6)
<b>Order example</b>	202823	-	24	-	733	-	102	-	600	/	920

<sup>1</sup> Other process connections on request.

**Note:**

The type code is not a modular system.  
 If possible, choose items listed under "**stock versions**" or "**production versions**" for your orders.  
 We will have to technically inspect and approve a free combination of individual key features.

**Production versions** (delivery approx. 3 weeks after receipt of order)

Type	Brief description	Sales No.
202823/24-733-101-600/920	Pneumatic retractable assembly, 1.4404 /316L stainless steel, DN50 flange, internal G 1/4" cleaning connection, EPDM seals, pneumatic positional feedback	20/00542770

**Accessories** (delivery approx. 4 weeks after receipt of order)

Type	Brief description	Sales No.
EXmatic 460 controller	Plastic housing, prepared for 2 cleaning solutions, drain valve controller, 5 m connecting cable	20/00542772
T-piece mounting	1.4571 / 316Ti stainless steel material, 180 ° flow, DN25 process connection flange, DN50 fitting connection flange	20/00542773
Cleaning valve kit	2 cleaning valves and 1 drain valve, incl. fixing bracket and connection hoses	20/00542776